

ZW-5 series

HITACHI

Reliable solutions

ZW220



WHEEL LOADER

Model Code: ZW220-5B
Max. Engine Power: 145 kW (194 HP)
Operating Weight: 17 700 - 18 030 kg
Bucket ISO Heaped: 2.4 - 3.5 m³



WALK AROUND

CONTENTS

4-5 Comfort

A comfortable work space enhances operational efficiency

6-7 Advanced technology

Hitachi is renowned for manufacturing technologically advanced machines that deliver an outstanding level of performance

8-9 Environmental awareness

The ZW220-5 has a positive effect on levels of safety and sustainability

10-11 Productivity

New hydraulics and gearshift systems, plus enhanced maneuverability, ensure maximum productivity

12-13 Maintenance

Daily inspections can be carried out quickly and easily, which increases the availability of the ZW220-5

14-15 Hitachi Support Chain

Customers can choose from a comprehensive range of after-sales services

16-19 Specifications

Advanced technology

The quick power switch boosts the power of the ZW-5 wheel loader when required by changing the work mode.

Lower fuel costs

The new ZW-5 wheel loader can work in two modes, which provide an appropriate level of performance for a particular job. One is for regular operations with the benefit of efficient fuel consumption; the other is for more demanding tasks and increases productivity. The optional auto-engine shutdown function avoids fuel wastage while the machine is long idling.

High productivity

A new hydraulic circuit facilitates the combined operation of the bucket and lift arm for loading and prioritises use of the bucket for loading work.

Sustainable operation

A muffler filter captures air pollutants, which are automatically burnt thanks to an oxidation catalyst and exhaust temperature control.

Powerful engine

The 6.7-litre six-cylinder water-cooled turbo engine enables a powerful digging performance, impressive travel speeds and benefits from excellent fuel consumption.

Heavy-duty axle

Hitachi axles are renowned for high performance and durability – ideal for working on demanding job sites.



ZW220

The new Hitachi ZW220-5 wheel loader has been designed with one aim in mind: empowering your vision. In terms of productivity, comfort, advanced technology, environmental performance and maintenance, it delivers on all levels. It not only meets our customers' expectations of high-quality, reliable machines, but also provides operators with a safer working environment, a comfortable cab with easy-to-use controls, and overall, a machine that responds quickly and precisely. To ensure optimum availability of the new ZW220-5, we have incorporated easy maintenance features into its design. We also offer the flexible Hitachi Support Chain after-sales programme to customers who wish to further enhance its uptime and protect their investment.

Spacious cab

The heated air-suspension seat can slide further back, providing more legroom. The tilting telescopic pop-up steering column has also been repositioned to create additional space.

Ultimate comfort

An air-conditioning system regulates the temperature inside the cab and an optional filter is available for industrial waste job sites. Sound insulation reduces noise levels from the local environment.

Easily accessible information

The new large multi-function LCD screen displays information at a glance and the adjustment function to the operator.

Operator safety

A pillar-less windshield and large sun visor have enhanced visibility levels from the operator's seat.

Controlled movement

A new clutch cut-off system allows for smooth operation when the ZW-5 wheel loader is loading.

Quick and easy service access

The redesigned engine cover provides easy access to inspection points and allows for quick maintenance at ground level.

Transmission control

The automatic transmission selects the appropriate gear for travelling and digging.





COMFORT

The spacious cab of the new ZW220-5 wheel loader was designed to offer maximum comfort. Several modifications have been made to create more room, provide greater visibility and offer a pleasant working environment for operators. Practical and user-friendly features have been incorporated to help you work quickly and easily. The ultimate aim was to improve the overall user experience of Hitachi ZW-5 wheel loaders, so you could enjoy your work and feel less fatigued at the end of the day.

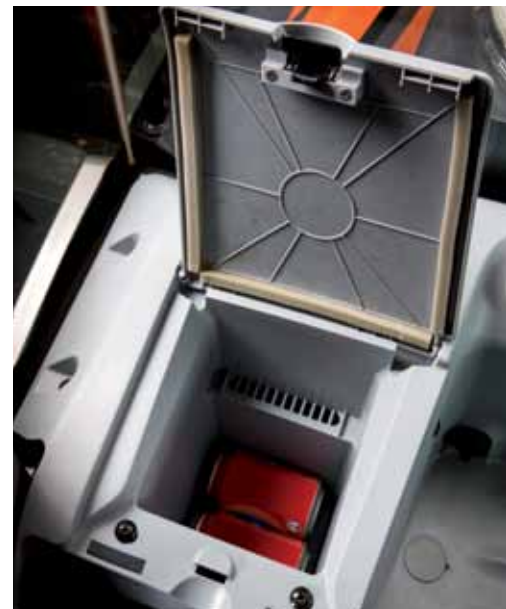

For operator comfort, the ZW-5 series is second to none



Take a seat

Hitachi has prioritised operator comfort in the design of the ZW-5 range of wheel loaders to give you a greater sense of enjoyment during your working day.

The sloped ladder and wide steps allow quick and easy access to the cab. The heated air-suspension seat with adjustable lumbar support can slide back further than ever before, allowing more leg room. The wrist and arm rests and right-hand side console can be adjusted to achieve a comfortable sitting position, and the tilting telescopic and pop-up steering column has also been repositioned to create additional space.

Pleasant working conditions

Busy construction sites and quarries can be stressful environments to work in, but Hitachi has installed a range of features in the new ZW-5 wheel loaders to make you feel more relaxed wherever you are.

An effective air conditioning system regulates the temperature within the cab. An optional air-conditioning filter can also be fitted for working in industrial waste and indoor disposal facilities. Noise levels within the cab have been reduced thanks to a high level of sound insulation.

Space for storage

Working long shifts means that you can spend most of your day in the cab of the ZW-5 wheel loader. Hitachi has incorporated several practical features to make you feel more at home.

There is a large space for a lunch box to be placed behind or at the side of the seat. The cab also has a large cool box, which is cooled by the air conditioner, with enough storage space for four cans or bottles. The cab also has a drinks holder, designed to hold a 1.5-litre bottle.

Enjoy your day

A happy operator is also a more productive one. That's why we have enhanced the versatility of the audio equipment, so you can listen to your favourite music while you work.

The AM/FM stereo radio now has an auto-tuning feature and the two-speaker stereo system provides excellent sound quality. It is also possible to connect this with your personal MP3 player thanks to the inclusion of an MP3 dock. The new multi-function LCD monitor has a large seven-inch screen and it provides a wide range of useful technical information with multi-lingual support.

Key features

- | | |
|--|---|
| ■ Heated air-suspension seat | ■ Effective air conditioning |
| ■ Expansive leg room | ■ Tilting telescopic and pop-up steering column |
| ■ Ergonomically designed control panel | ■ Easy access via sloped ladder and wide steps |
| ■ New colour LCD monitor | ■ AUX terminal and storage for MP3 player |



ADVANCED TECHNOLOGY

Several decades of experience in manufacturing construction equipment have placed Hitachi at the forefront of the industry. Its technologically advanced machines are renowned around the world. The new ZW220-5 has been developed using this expertise and has the capability of exceeding previous levels of performance and productivity. In addition, many of the features on the new ZW-5 wheel loader range will result in lower fuel consumption and a reduced impact on the environment.



A superior performance is guaranteed



Simple work mode ①

The new ZW-5 wheel loader can operate in two modes to ensure lower fuel consumption and maximise productivity: Standard mode is for regular duties such as loading materials; and P mode is chosen for more demanding tasks such as heavy duty digging.

In Standard mode, the engine speed is controlled, which allows for smooth and efficient acceleration during loading, regular operations and travelling on level terrain. Fuel consumption is reduced by up to 10%, enhancing its environmentally friendly performance.

The P mode is useful when greater traction force is required for heavy-duty excavation and travelling uphill. By fully utilising the engine's capability, it allows for powerful digging and a quick ascent up gradual slopes.



Quick power switch ②

The operator can boost the power of the ZW-5 wheel loader at the push of a button. The Quick power switch changes the mode from Standard to P and can be used when the machine is travelling uphill with a full load or when greater breakout force is required.



Clutch cut-off ③

The new clutch cut-off system controls clutch timing for smoother operation, according to travel speed and the amount of stroke of the brake pedal. When travelling at high speed on flat terrain, the clutch can be released early so the wheel loader slows down smoothly with the application of the brake pedal.

When travelling slowly uphill, the clutch is released by deeply depressing the pedal to allow for easy unloading.

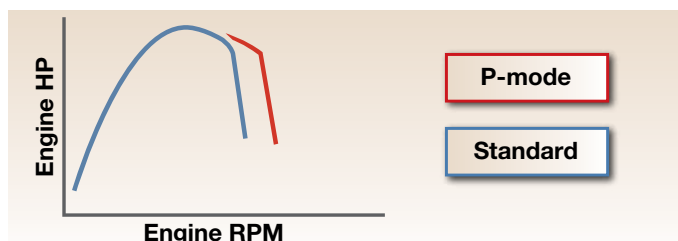

Key features

■ Simple work mode

■ Quick power switch

■ Clutch cut-off



ENVIRONMENTAL AWARENESS

The environment was an important design consideration for the new range of ZW-5 wheel loaders. The ZW220-5 has been developed to have a positive impact on both safety and sustainability. It satisfies the latest EU regulations on emission standards and has a variety of fuel-efficient features, which help to reduce running costs. With greater all-round visibility from the cab, the ZW220-5 also contributes to enhanced safety and the successful operation of any job site.



The ZW220-5 contributes to a cleaner, safer environment



A cleaner environment

The new ZW-5 wheel loader range epitomises our efforts to minimise the impact of construction machinery on the environment in compliance with EU emission control stage IIIB.

The ZW-5 has been fitted with a muffler filter to capture air pollutants, which is automatically burnt thanks to an oxidation catalyst and exhaust temperature control. The variable geometry turbocharger – that encourages optimal combustion – and cooled-EGR (Exhaust Gas Recirculation) also help to reduce nitrous oxide levels.

The optional auto-engine shutdown function helps to prevent fuel wastage by stopping the engine while the wheel loader is long idling. In addition, all resin parts on the new ZW-5 are suitable for recycling and clearly marked for ease of use in this process. The ECO display visualises ECO drive and results in a fuel-saving performance.

A safer environment

The operator of the ZW-5 can relax with the knowledge that he is working in a safer environment. The new wheel loader offers excellent visibility from all angles. The view from the cab is enhanced by a pillar-less windshield, a large sun visor and additional glass panels in the door.

Looking to the rear of the machine, the counterweight is now visible on both sides, which is particularly useful for working on small job sites. The rear-view monitor satisfies the European visibility standard and allows the operator to see right behind the machine. The color display in the front console is easy to view and works automatically when the FNR lever/switch is reverse position.

Shift-up delay to third gear

This system delays the timing of the shift-up to the 3rd gear to enhance safer operation of the ZW-5 wheel loader in confined spaces. The wheel loader can perform excavating and unloading tasks more safely in first and second gear.

Key features

■ Fuel-saving work mode

■ Auto-engine shutdown (optional)

■ Muffler filter and ECO display

■ Pillar-less windshield

■ Large sun visor

■ Both sides of counterweight visible

■ Rear-view monitor

■ Shift-up delay to third gear



PRODUCTIVITY

The new Hitachi ZW220-5 wheel loader has been built to exceed your expectations. The design incorporates a new hydraulic circuit and a smooth lift arm movement, which help to boost efficiency on the job site. Productivity has also been increased by the wheel loader's enhanced maneuverability, due to the automatic gearshift controls. With the new ZW-5 range, you can look forward to a quick return on your investment and greater profitability.



Designed to improve efficiency on the job site



Increased efficiency

We have designed the latest range of ZW-5 wheel loaders to offer increased productivity – without burdening the environment – through sustainable operations.

It is equipped with a new hydraulic circuit, which facilitates the combined operation of the bucket and lift arm for loading, and prioritises use of the bucket for unloading.

The lift arm movement also makes a contribution to the new ZW-5's high productivity levels. The lowering of the lift arm stops smoothly thanks to the flow control, resulting in fewer vibrations and less operator fatigue. The anti-drift valve blocks internal leaking of oil and stops creeping of the lift arm.

The height of the lift arm kick-out and lift arm auto leveller are easily adjusted using the monitor in the front console.

Enhanced maneuverability

The maneuverability of the ZW-5 wheel loader series has been enhanced by automatic gearshift controls.

The Auto 1 option automatically shifts between first and fifth gears, depending on the load, when second to fifth gears have been engaged.

The Auto 2 option automatically shifts between second and fifth gears, relative to the load. The operator can also change gear manually using the Down Shift Switch, if required, to suit the terrain on any job site.

The ZW-5 series is equipped with a ride control feature that reduces vibration while the wheel loader is travelling on rough ground or snow. In auto mode, it turns on and off automatically while the wheel loader is in operation.

Key features

■ Powerful and sustainable

■ Ride control

■ Automatic gearshift

■ New hydraulics circuit

■ Smooth lowering of lift arm

■ Environmentally friendly design

■ Anti-drift system

■ Adjustable kick-out height and auto leveller



MAINTENANCE

Wherever you operate the new ZW220-5 wheel loader, high levels of availability are guaranteed. This is thanks to a number of features that allow quick and easy routine maintenance procedures. Daily checks can be made at ground level, for example, because the engine and radiator cover can be opened fully, providing convenient access. The new ZW-5 wheel loaders have been designed to make life easier on the job site, allowing you to work productively and keep downtime to an absolute minimum.



Work for longer with the ZW-5 wheel loader



Easy access

Hitachi has introduced a range of time-saving features on the new ZW-5 wheel loaders, which are designed to make life easier for you on the job site.

Many of the covers on the machine can be opened fully so you can access maintenance points quickly and easily on a daily basis. Many features – such as the greasing points, oil levels and the fuel filters – can be accessed at ground level.

For operation in dust-filled environments, the ZW-5 wheel loader can be equipped with an optional wide-pitch fin radiator to prevent clogging.

Using the technology within the multi-function LCD monitor you can set the routine service schedule to help prevent breakdowns each time the ignition switch is turned on.

Easy cleaning

Quick and easy routine maintenance is essential for you to achieve high levels of productivity on the job site. The new Hitachi ZW wheel loaders are capable of working for longer thanks to convenient features, such as the automatic reversible cooling fan.

The fan allows for easy cleaning of the radiator with its one-minute automatic reverse rotation every 30 operating minutes. In moderate working conditions, this can be manually operated for cleaning as necessary. Dust from the radiator can be easily cleared through the slide opening of the condenser.

Key features

- Daily checks from ground level
- Automatic reversible cooling fan
- Quick and easy service access
- Optional wide-pitch fin radiator



SUPPORT CHAIN

Once you have taken delivery of your ZW220-5 wheel loader, we want to ensure that it continues to exceed your expectations on the job site. That's why we provide extensive support to each of our European dealers so that every one of our customers can receive first-class after-sales service. To further protect your investment, you can choose from a variety of options within the Hitachi Support Chain programme. It gives you the flexibility to create your own service plan from the following key areas – each one represents a link in the chain of service available from Hitachi via your local dealer.



Protect your investment with a variety of after-sales options

Global e-Service

The new ZW-5 wheel loader is equipped with a GPRS communication system*. This sends a wide range of machine data to the Hitachi main server. Via the Global e-Service database, you will have remote access to all of this data. All you need is an internet connection and your Global e-Service log-in details.

Global e-Service enables you and your dealer to download and share this data, helping you to remotely manage your fleet. The online facility also helps your dealer to proactively advise you on preventive maintenance and related special offers.

The latest information on the ZW-5 wheel loader is available 24/7 and includes operational data, such as the number of working hours, fuel consumption figures, working modes and location. This helps you to reduce running costs, plan jobs efficiently and keep up to date with machine maintenance – to ensure optimum performance and minimal downtime.

Technical support

The professional and highly trained Hitachi service team combines the global expertise and knowledge of Hitachi Construction Machinery with your local language and culture. We take a proactive approach towards customer service by continuously training our dealer personnel, so that the available global knowledge is passed on to each individual technician in our dealer network.

Extended warranty and service contracts

Every new Hitachi model is covered by a full manufacturer's warranty. However, your ZW-5 wheel loader may require extra protection due to severe working conditions or to minimise equipment repair costs. To meet these demands, our dealers offer the option of a unique extended warranty programme (HELP – Hitachi Extended Life Program) and comprehensive service contracts – the most effective way to optimise the performance of your new ZW-5 wheel loader.

Parts and Remanufactured Components

Hitachi offers different lines of parts and components to suit your specific needs. In addition to our range of genuine parts, there are other options available:

- If your machines have been working for several years, Hitachi can offer a second line of genuine parts as an attractively priced solution.
- For that highly demanding application or climate, Hitachi provides a line of parts with extra performance.
- When you are looking for an economical solution for preventive replacements, remanufactured components are the best option.

Whatever choice you make, you can be assured of the renowned Hitachi quality and warranty to give you added peace of mind.

Your Hitachi dealer can supply you with more details on each of the above parts lines.



* The GPRS communication system is standard equipment for new ZW wheel loaders, however, the availability of the communication system depends on licensing regulations in your country. Please contact your Hitachi dealer for more information or to apply for a Global e-Service account.

Key features

- Check each of your machines from your office – 24/7
- Have a remote insight into fuel consumption
- Check the current and previous locations and movements of your machine(s)

- See maintenance status and items due for renewal on each of your machines
- Receive e-mail notifications for any machine alerts, unexpected movements and so on

SPECIFICATIONS

ENGINE

Model	CUMMINS QSB6.7
Type	4-cycle water-cooled, direct injection
Aspiration	Turbocharger and intercooled
Aftertreatment	Muffler filter
No. of cylinders	6
Maximum power	
Gross	149 kW (200 HP) at 1 900 min ⁻¹ (rpm)
ISO 9249, net	145 kW (194 HP) at 1 900 min ⁻¹ (rpm)
Maximum torque	929 Nm at 1 400 min ⁻¹ (rpm)
Bore and stroke	107 mm X 124 mm
Piston displacement	6.690 L
Batteries	2 x 12 V
Air cleaner	Two element dry type with restriction indicator

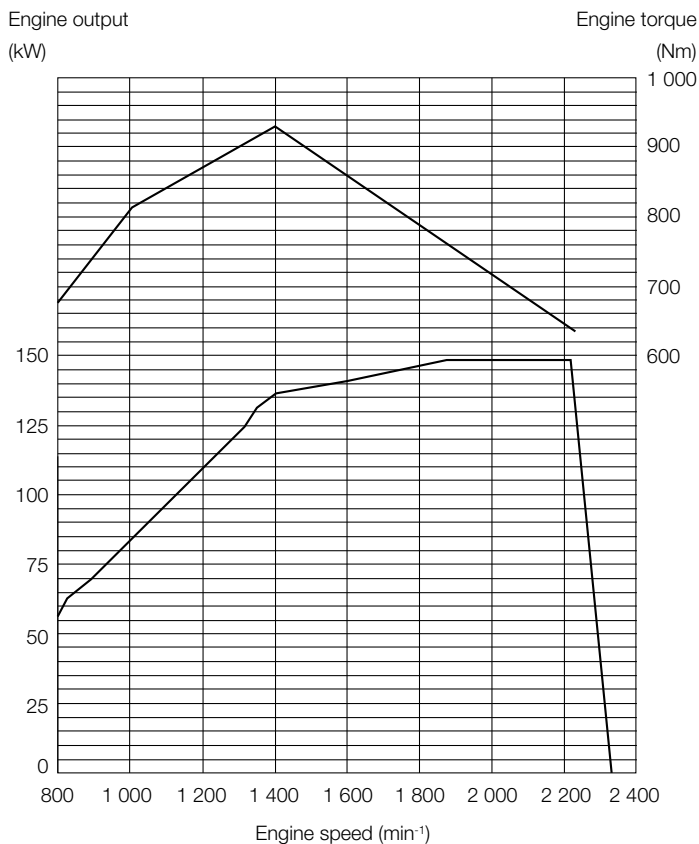

POWER TRAIN

Transmission	Torque converter, countershaft type powershift with computer-controlled automatic shift and manual shift features included.
Torque converter	Three element, single stage, single phase
Main clutch	Wet hydraulic, multi-disc type
Cooling method	Forced circulation type
Travel speed* Forward / Reverse	
1st	6.2 / 6.5 km/h (6.5 / 6.8 km/h)
2nd	10.6 / 11.1 km/h (11.1 / 11.7 km/h)
3rd	16.0 / 24.9 km/h (16.8 / 26.2 km/h)
4th	23.8 km/h (25.0 km/h)
5th	36.0 km/h (36.0 km/h)
*With 23.5 R25 (L3) tires	
() : Data at Power Mode	

AXLE AND FINAL DRIVE

Drive system	Four-wheel drive system
Front & rear axle	Semi-floating
Front	Fixed to the front frame
Rear	Trunnion support
Reduction and differential gear	Two stage reduction with torque proportional differential
Oscillation angle	Total 24° (+12°, -12°)
Final drives	Heavy-duty planetary, mounted inboard

TIRES

Tire size	23.5 R25 (L3)
Optional	Refer to standard & optional equipment list

BRAKES

Service brakes	Inboard mounted fully hydraulic 4 wheel wet disc brake. Front & rear independent brake circuit
Parking brakes	Spring applied, hydraulically released, dry disc type with external output shaft

STEERING SYSTEM

Type	Articulated frame steering
Steering angle	Each direction 37° ; total 74°
Cylinders	Double-acting piston type
No. x Bore x Stroke	2 x 70 mm x 442 mm

HYDRAULIC SYSTEM

Arm and bucket are controlled by independent control lever	
Arm controls	Four position valve ; Raise, hold, lower, float
Bucket controls with automatic bucket return-to-dig control	Three position valve ; Roll back, hold, dump
Main pump (Serve as steering pump)	
.....	Variable Displacement Axial Plunger Pump
Maximum flow	275 L/min at 2 200 min ⁻¹ (rpm)
Maximum pressure ..	27.4 MPa
Fan pump	
.....	Fixed Displacement Gear Pump
Maximum flow	65.8 L/min at 2 200 min ⁻¹ (rpm)
Maximum pressure ..	19.0 MPa
Hydraulic cylinders	
Type	Double acting type
No. x Bore x Stroke ...	Arm : 2 x 130 mm x 880 mm
	Bucket : 1 x 165 mm x 510 mm
Filters	Full-flow 15 micron return filter in reservoir
Hydraulic cycle times	
Lift arm raise	5.9 s (5.6 s)
Lift arm lower	3.3 s (3.3 s)
Bucket dump	1.6 s (1.5 s)
Total	10.8 s (10.4 s)
() : Data at Power Mode	

SERVICE REFILL CAPACITIES

Fuel tank	255 L
Engine coolant	28.0 L
Engine oil	25.0 L
Torque convertor & transmission	40.0 L
Front axle differential & wheel hubs	32.0 L
Rear axle differential & wheel hubs	32.0 L
Hydraulic oil tank	114 L

DIMENSIONS & SPECIFICATIONS

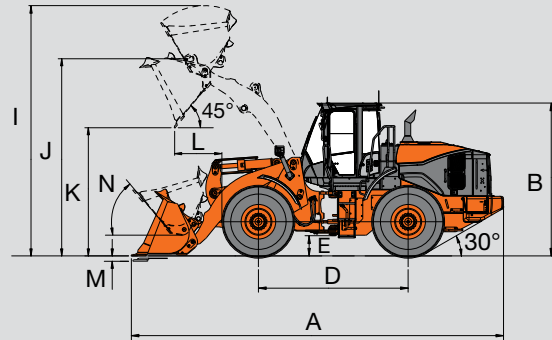
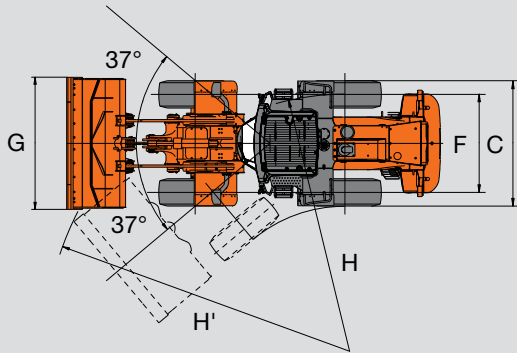

Bucket type			Standard arm				High lift arm		
			General purpose				Rock bucket		General purpose
			Bolt-on teeth	Bolt-on cutting edge	Bolt-on teeth	Bolt-on cutting edge	Bolt-on teeth	Bolt-on cutting edge	
Bucket capacity	ISO heaped	m ³	3.1	3.3	3.3	3.5	2.4	2.7	
	ISO struck	m ³	2.7	2.8	2.8	3.0	2.0	2.3	
A Overall length		mm	8 360	8 220	8 410	8 270	8 170	8 560	
B Overall height		mm				3 370			
C Width over tires		mm				2 825			
D Wheel base		mm				3 300			
E Ground clearance		mm				450			
F Tread		mm				2 160			
G Bucket width		mm				2 910			
H Turning radius (Centerline of outside tire)		mm				6 010			
H' Loader clearance radius, bucket in carry position		mm	6 980	6 940	6 990	6 950	6 930	7 100	
I Overall operating height		mm	5 480	5 480	5 540	5 540	5 380	5 790	
J Height to bucket hinge pin, fully raised		mm	4 080	4 080	4 080	4 080	4 080	4 490	
K Dumping clearance 45 degree, full height		mm	2 810	2 900	2 770	2 870	2 940	3 420	
L Reach, 45 degree dump, full height		mm	1 210	1 110	1 250	1 150	1 120	1 160	
M Digging depth (Horizontal digging angle)		mm	110	110	110	110	80	190	
N Max. roll back at carry position		deg				47			
Static tipping load *	Straight	kg	15 010	14 720	14 970	14 660	14 650	11 840	
	Full 37 degree turn	kg	13 290	13 010	13 240	12 950	12 940	10 430	
Breakout force		kgf	16 350	14 980	15 660	14 360	18 880	15 740	
		kN	160	147	154	141	185	154	
Operating weight *		kg	17 700	17 830	17 740	17 870	18 030	17 940	

Note: All dimensions, weight and performance data based on ISO 6746-1:1987, ISO 7131:2009 and ISO 7546:1983

: Static tipping load and operating weight marked with include 23.5 R25 (L3) tires (No ballast) with lubricants, full fuel tank and operator.
Machine stability and operating weight depend on counterweight, tire size and other attachments.

WEIGHT CHANGE

Option item		Operating weight (kg)	Tipping load (kg)		Overall width (mm) (outside tire)	Overall height (mm)	Overall length (mm)
			Straight	Full turn			
Tire	23.5R25(L3)	±0	±0	±0	±0	±0	±0
	23.5R25(L4)	+600	+520	+470	+15	+30	-25
	23.5R25(L5)	+710	+620	+560	+10	+25	-20
	23.5-25-16PR(L3)	-100	-90	-80	-40	+10	-10
	23.5-25-20PR(L3)	-60	-60	-50	-40	+10	-10
Belly guard		+170	+140	+130	-	-	-

BUCKET SELECTION GUIDE

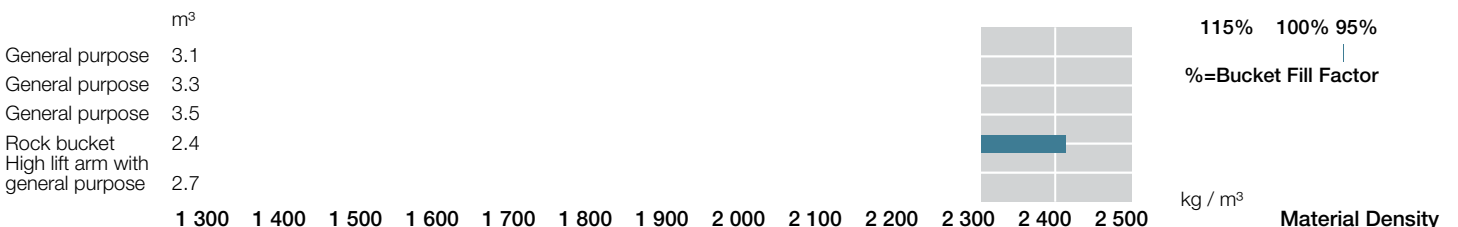

EQUIPMENT

● Standard equipment

○ Optional equipment

OPERATOR'S STATION

Adjustable steering column with POP-UP	●
Air suspension seat with headrest and heater: fabric, high back, adjustable for damper, inclination of the seat, seat depth, weight-height, fore-aft position, reclining angle, armrest angle, headrest height and angle, lumbar support	●
AM/FM radio with AUX for digital audio player	●
Ashtray, cigar lighter	●
Auto control air conditioner	
with single intake filter	●
with double intake filter	○
Coat hook	●
Front/Rear defroster	●
Glove compartment	●
Rear view mirrors	
Inside (2)	●
Outside (2)	●
Outside (Heated, 2)	○
Retractable seat belt, 50mm	●
ROPS (ISO3471), FOPS (ISO3449): multi-plane isolation mounted for noise, vibration reduction	●
Rubber floor mat	●
Storage	
Cup holder	●
Digital audio player holder	●
Document holder	●
Hot & cool box	●
Rear view camera & monitor	●
Seatback pocket	●
Sun visor	●
Textured steering wheel with spinner knob	●
Tinted safety glass: others : tempered, windshield : laminated	●
Windshield washer front and rear	●
Windshield wipers front and rear	●

ELECTRICAL SYSTEM

Backup alarm	●
Batteries	
Standard batteries (120AH-760A)	●
Large capacity batteries (155AH-900A)	○
Battery disconnect switch	○
Engine auto shut-down control system	○
Immobilizer key	○
12V power outlet	○

COOLING SYSTEM

Automatic reversible cooling fan with heat sensing	●
Fan guard	●
Radiator	
Standard fin pitch radiator	●
Wide fin pitch radiator	○

LIGHTS

Brake & tail lights	●
Clearance lights	●
Headlights	●
Rotating lamp	○
Turn signals with hazard switch	●
Work lights	
Front lights on cab (2)	●
Rear lights on rear grille side cover (2)	●
Additional front lights on cab (2)	○
Rear lights on cab (2)	○

POWER TRAIN

Automatic transmission with load sensing system	●
Clutch cut position switch	●
Differential	
TPD (Torque Proportioning Differential, front and rear)	●
LSD (Limited Slip Differential, front and rear)	○
Driving speed limiter (20km/h)	○
DSS (Down Shift Switch)	●
Forward/Reverse lever	●
Forward/Reverse selector switch	●
Power mode switch	●
Quick power switch	●
Travel mode selector (Auto1-Auto2)	●
1st speed fixed switch	●

ENGINE

Air intake	
Rain cap	●
Pre-cleaner (Sy-Klone)	○
Pre-cleaner (Turbo II)	○
Air filter double elements	●
Cartridge-type engine oil filter	●
Cartridge-type fuel pre-filter	●
Cartridge-type fuel main filter	●
Engine oil remote drain	●







MONITORING SYSTEM

Gauge: coolant temperature, fuel	●
Indicator lights: clearance lights, control lever lock, fuel level, high beam, parking brake, preheat, turn signals, work lights	●
Indicator on multifunction monitor: air conditioner display, auto shut-down, brake oil pressure gauge, clock, clutch cut off indicator, dual lift arm auto leveler, ECO indicator, fan reverse indicator, F-N-R/Shift position, forward/reverse selector switch indicator, hold display, hour meter, muffler filter, odometer, power mode indicator, ride control indicator, seat belt, speedometer, tachometer, transmission auto-shifting indicator, transmission oil temperature	●
Warning lights: air filter restriction, brake oil low pressure, communication system error, discharge warning, engine oil low pressure, engine warning, hydraulic oil level, low steering oil pressure, overheat, transmission warning	●

BRAKE SYSTEM

Front & rear independent brake circuit	●
Inboard mounted fully hydraulic 4 wheel wet disc	●
Spring-set/Hydraulic-released parking brake	●

HYDRAULIC SYSTEM

Bucket auto leveler (Automatic return to dig control)	●
Control lever	
for 2 spools control valve	
Multifunction lever (MF lever)	●
	
2 levers	○
	
for 3 spools control valve	
MF lever & AUX lever for 3rd function	○
	
2 levers & AUX lever for 3rd function	
	
- Inside layout pattern (3rd - bucket - liftarm)	○
- Outside layout pattern (Bucket - liftarm - 3rd)	○
for 4 spools control valve	
MF lever & AUX joystick lever for 3rd & 4th function	○
	
2 levers & AUX 2 levers for 3rd & 4th function	
- Inside layout pattern (4th - 3rd - bucket - liftarm)	○
	
2 levers & AUX joystick lever for 3rd & 4th function	○
	
Control lever lock switch	●
Dual lift arm auto leveler	●
Hydraulic filters	●
Lift arm float system	●
Reservoir sight gauge	●
Ride control system (OFF-AUTO type)	●

TIRES

23.5 R25 (L3)	●
23.5 R25 (L4)	○
23.5 R25 (L5)	○
23.5-25-16 PR (L3)	○
23.5-25-20 PR (L3)	○

MISCELLANEOUS

Articulation lock bar	●
Auto lubrication system	○
Belly guard (Bolt on type)	○
Bucket cylinder guard	○
Counterweight, built-in	●
Drawbar with locking pin	●
Emergency steering	●
Fenders	
for 23.5 R25	
Front & full covered rear fenders with mud flaps	●
Front & half covered rear fenders	○
Front & half covered rear fenders with mud flaps	○
Global e-service	●
Lift arm	
Standard lift arm	●
High lift arm	○
Lift & tie down hooks	●
On board information controller	●
Pilfer proof	
Battery cover with locking bracket	●
Lockable engine cover	●
Lockable fuel refilling cap	●
Road homologation	
German road homologation kit: rear license plate bracket, reflective sticker, wheel blocks	○
Italian road homologation kit: cab lights, cutting edge protection, link stopper, rear license plate bracket, reflective sticker, rotating lamp	○
Cutting edge protection	○
Wheel blocks	○
Rear licence plate bracket	○
Theft prevention system*	○

Standard and optional equipment may vary by country, so please consult your Hitachi dealer for details.

* Hitachi Construction Machinery cannot be held liable for theft, any system will just minimize the risk of theft.



Built on the foundation of superb technological capabilities, Hitachi Construction Machinery is committed to providing leading-edge solutions and services to contribute as a reliable partner to the business of customers worldwide.

Hitachi Environmental Vision 2025

The Hitachi Group released the Environmental Vision 2025 to curb annual carbon dioxide emissions. The Group is committed to global production while reducing environmental impact in life cycles of all products, and realizing a sustainable society by tackling three goals — prevention of global warming, recycling of resources, and enhancement of ecosystem.

Reducing Environmental Impact by New ZW

Hitachi makes a green way to cut carbon emissions for global warming prevention according to LCA*. New ZW utilizes lots of technological advances, including the new standard mode which optimize fuel efficiency. Hitachi has long been committed to recycling of components, such as aluminum parts in radiators and oil cooler. Resin parts are marked for recycling.

*Life Cycle Assessment – ISO 14040

Prior to operating this machine, including satellite communication system, in a country other than a country of its intended use, it may be necessary to make modifications to it so that it complies with the local regulatory standards (including safety standards) and legal requirements of that particular country. Please do not export or operate this machine outside the country of its intended use until such compliance has been confirmed. Please contact your Hitachi dealer in case of questions about compliance. These specifications are subject to change without notice.

Illustrations and photos show the standard models, and may or may not include optional equipment, accessories, customer installed and modified parts, optional parts and all standard equipment with some differences in color and features. Before use, read and understand the Operator's Manual for proper operation.

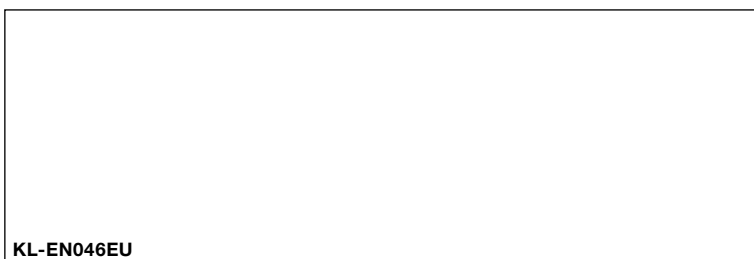

KL-EN046EU